

2041411 A1  
15.06.2012

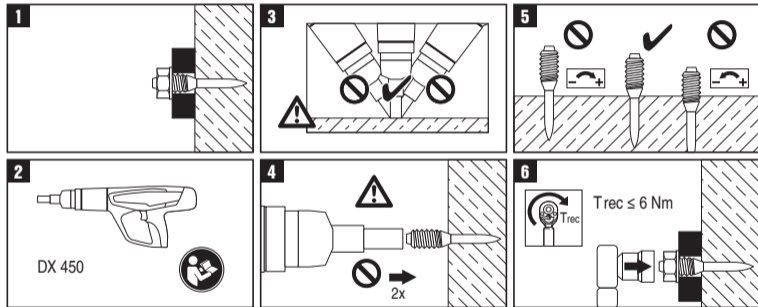

2041411 A1-06.2012